



CORNELL PUMP COMPANY INDUSTRIAL



EFFICIENT BY DESIGN



CORNELL'S INDUSTRIAL PRODUCT LINE

WHAT SETS CORNELL INDUSTRIAL PUMPS APART

Cornell Pump has been producing robust, high-efficiency pumps for the Industrial market since 1946 and our innovative pumps have provided unmatched value. Cornell clear liquid, solids handling, and grit/slurry pumps provide the reliability and inter-changeability demanded in industrial applications. Cornell offers a wide range of pump models and configurations to fit into existing installations. We'll also work with you to create a custom system to satisfy your needs. Our technical and engineering staff is the best in the business at providing high quality, innovative pump solutions.

A WIDE VARIETY OF SIZES AND CONFIGURATIONS

Models range in size from 1" to 30" and a range of configuration options are available for each model – including frame and engine mount options and Cornell features like Run-Dry™ and Redi-Prime®.

PUMPS DESIGNED FOR SPECIFIC JOBS

Our team of expert engineers design pumps to meet the varying demands of industry applications, such as solids handling, slurry, and head requirements.

OUTSTANDING EFFICIENCIES

We put our experience and knowledge to work to produce tested designs with some of the highest efficiencies of any pumps on the market.

ROBUST CONSTRUCTION

Cornell pumps are built using superior materials selected for their suitability to each pump's intended application. Heavier casting walls, thicker shafts, and fully-machined impellers are part of what make Cornell pumps more rugged and durable than other pumps.



SELECT HIGH-EFFICIENCY PUMP MODELS

8H	88% efficient
6RB	89% efficient
5RB	86% efficient
4RB	85% efficient

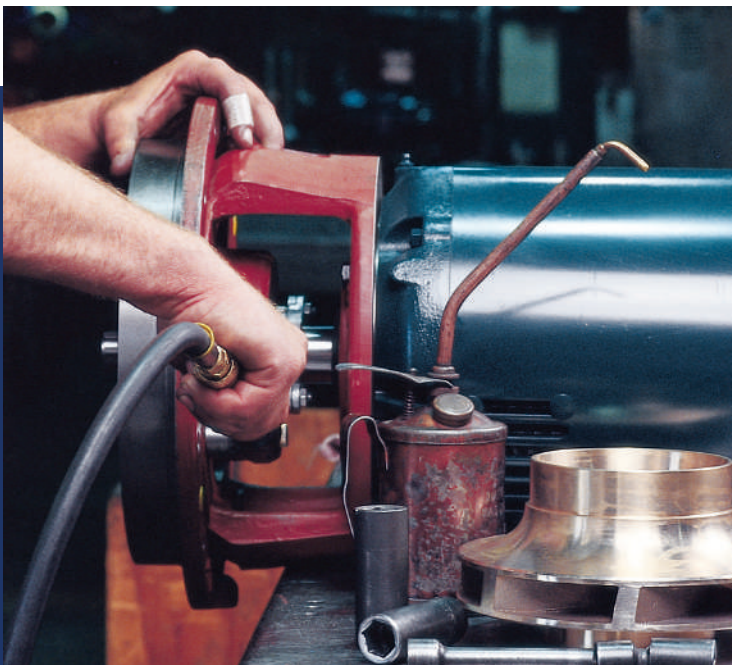

QUALITY ASSURANCE

Cornell Pump proudly maintains its ISO 9001:2008 certification that validates Cornell is in compliance with all necessary processes to meet customer requirements.

The elements associated with ISO 9001:2008 certification include such areas as contract review, design and development, production, purchasing, quality control and service.

PUMPS FOR INDUSTRY



WE PUT OUR BEST IDEAS TO THE TEST

Our modern hydraulics lab is the proving ground for all Cornell pumps. Our goal is to deliver the most efficient pumps at a time when energy costs are escalating. Technicians, under the direction of Registered Professional Engineers, conduct certified performance tests that precisely determine the performance and NPSH required for particular design conditions.

The focal point of the research facility is a 80,000 gallon closed loop system for running accurate low pressure tests. It can circulate up to 60,000 gallons of water per minute. All test motors are calibrated, and adhere to the Hydraulic Institute Standards in testing. A variable frequency drive will allow us to test pumps up to 4,000 horsepower at various speeds. Additional tests can be conducted upon customer request.



CLEAR LIQUID PUMPS

Cornell Clear Liquid pumps work in a variety of applications from agriculture, irrigation, municipal potable water and industrial water transfer, to refrigeration and specialized food processing. Our Clear Liquid pumps are able to handle some solids in the mix, and depending on the pump can manage a solid up to 1.25".

EXTERNAL HYDRAULIC BALANCE LINE: Helps reduce axial thrust which prolongs bearing, shaft, and seal life. It equalizes pressure between the impeller hub area and the pump suction to reduce axial loading acting on the impeller, shaft and bearings.

PERFORMANCE

DISCHARGE SIZE RANGE	1" TO 10"
FLOW RANGE	10 TO 10,000 GPM
MAX HEAD	400'

MATERIALS OF CONSTRUCTION

- All iron pump end construction
- Cast iron bearing frames
- Shafts of carbon steel or stressproof steel
- Cast iron wear rings

FEATURES

- Excellent hydraulic efficiencies
- Low maintenance and operation costs
- Exceptional shaft and bearing life
- Replaceable wear rings and shaft sleeves
- Fully-machined impellers
- Shower curtain shield
- Double volute design
- Two-year warranty

PUMPS FOR INDUSTRY

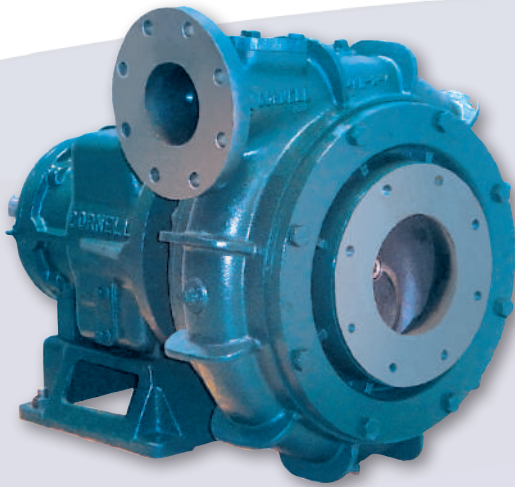

N-SERIES SOLIDS HANDLING PUMPS

Discharge sizes up to 30", flows up to 38,000 GPM, and solids up to 10.2".

IMPELLER CHOICES: choose from the Delta style impeller for heavy sludge, two and three port enclosed impellers for large solids, and three or four bladed, semi-open impeller with cutting action for the worst slurries/solids.

PERFORMANCE

DISCHARGE SIZE RANGE	3" TO 30"
MAX SOLIDS HANDLING	10.2"
MAX FLOW	38,000 GPM
MAX HEAD	500'

MATERIALS OF CONSTRUCTION

- Ductile or cast iron pump casings
- Some models available in CD4MCu
- Ductile, cast iron, or CD4MCu impellers
- Stressproof or heat treated steel shafts (stainless on CD4MCu)
- SAE 1144 stressproof steel
- 420HT wear rings and shaft sleeve available

FEATURES

- Cycloseal® grit removal system
- High-efficiency design
- Run-Dry Option
- Redi-Prime Option
- Excellent NPSHr
- Ruggedness and durability
- Two-year warranty



PUMPS FOR SLURRY APPLICATIONS

SP-SERIES PUMPS pass up to 4.1" solids. Rubber or metal lined, handles pH from 1 to 14 depending on configuration. Capable of pumping slurries that are up to 40% solids by volume.

PERFORMANCE

DISCHARGE SIZE RANGE	2" TO 12"
MAX SOLIDS HANDLING	4.1"
MAX FLOW	18,000 GPM
MAX HEAD	290'

MATERIALS OF CONSTRUCTION

- Chrome iron impellers
- Ductile iron volute casings
- Volute lining either chrome iron or rubber
- 4140 steel shafts
- Ductile iron bearing housing and cast iron bearing frames

FEATURES

- Cycloseal® grit removal system
- Enclosed impeller for higher efficiency
- Run-Dry Option
- Redi-Prime Option
- Superior abrasive and corrosive wear life
- No seal flush, vent line or lubrication required
- Various materials of construction
- Ruggedness and durability
- Two-year warranty

PUMPS FOR INDUSTRY



PUMPS FOR COARSE ABRASIVES

MP Series pumps are an unlined slurry pump designed for coarse abrasives and solids up to 3". The MP series offers exceptional wear resistance for reduced maintenance and long life in harsh environments.

ADJUSTABLE WEAR PLATE: to maintain lost efficiency while in service.

PERFORMANCE

DISCHARGE SIZE RANGE	2" TO 8"
MAX SOLIDS HANDLING	3"
MAX FLOW	9,000 GPM
MAX HEAD	625'

MATERIALS OF CONSTRUCTION

- Available in a ductile iron, chrome iron, or hybrid construction
- 17-4PH stainless steel shafts
- Hardness rating > 650BHN

FEATURES

- Cycloseal® grit removal system
- High-efficiency design
- Run-Dry Option
- Redi-Prime Option
- Heavy-duty construction for aggressive applications
- Replaceable wear plates
- Two-year warranty

SELF-PRIMING PUMPS

STX, STL, and STH pumps offer rugged construction and efficiencies up to 68%.

MODULAR DESIGN: Easy conversion to SAE engine-driven applications.

OVERSIZED OIL RESERVOIR: superior bearing cooling.

PERFORMANCE

DISCHARGE SIZE RANGE	2" TO 10"
MAX SOLIDS HANDLING	3"
MAX FLOW	4,500 GPM
MAX HEAD	275'

MATERIALS OF CONSTRUCTION

- Ductile iron volute casing, backplate, and impeller
- 17-4PH stainless steel shafts
- Optional CD4MCu on 3STX, 4STX, and 6STX pump models

FEATURES

- Cycloseal® grit removal system
- High-efficiency design
- High RPM capacity for engine driven applications.
- High head capacity
- Modular design
- ANSI, NPT, and DIN flanges available
- Five-year warranty

HIGH HEAD PUMPS

Cornell's MX high head mining pump series provide heads up to 800', long service life, and industry-leading efficiency.

PERFORMANCE

DISCHARGE SIZE RANGE	2" TO 8"
MAX SOLIDS HANDLING	2.38"
MAX FLOW	8,000 GPM
MAX HEAD	800'

MATERIALS OF CONSTRUCTION

- Ductile iron casings
- 17-4PH stainless steel shafts
- CA6NM impellers
- Optional hardened wear ring and shaft sleeves.

FEATURES

- Cycloseal® grit removal system
- High-efficiency design
- Run-Dry Option
- Redi-Prime Option
- High operating pressures
- Two-year warranty

CORNELL FEATURES & BENEFITS

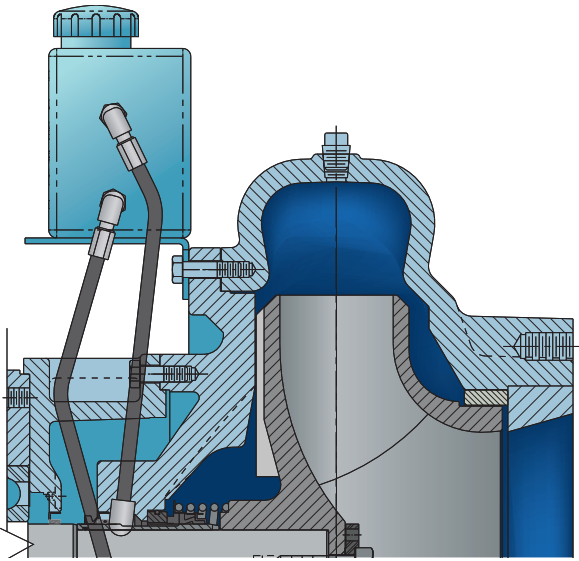

RUN-DRY™ SEAL PROTECTION

Cornell's Run-Dry system consists of an auxiliary gland and oil reservoir that keeps the seal faces lubricated and prevents dry running of the seal faces during priming, re-priming, or standby operation.

- Run dry for hours without damaging the seal
- Cools and lubricates seal faces
- Ideal for applications that could experience dry operation
- Useable in conjunction with Cycloseal® and Redi-Prime®

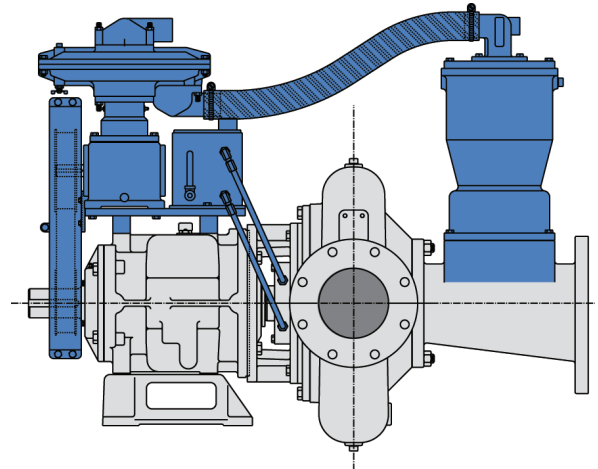

REDI-PRIME® DRY-PRIMING OPTION

Cornell Redi-Prime pumps are designed with oversized suctions to provide more flow, reduced friction losses, and higher suction lift. The priming system was designed with the environment in mind. By using a positive sealing float box and a diaphragm vacuum pump, there is no water carry-over to contaminate the environment. Redi-Prime is offered on all Cornell industrial pumps, and is available in virtually every other pump we manufacture as well.

- Fully automatic priming and repriming
- Handles air/liquid mixtures with ease
- Rapidly primes and re-priming completely unattended
- Environmentally safe priming system designed to prevent product leakage
- Handles large sized solids
- High suction lift capability up to 28 feet
- Premium hydraulic efficiency for reduced energy consumption

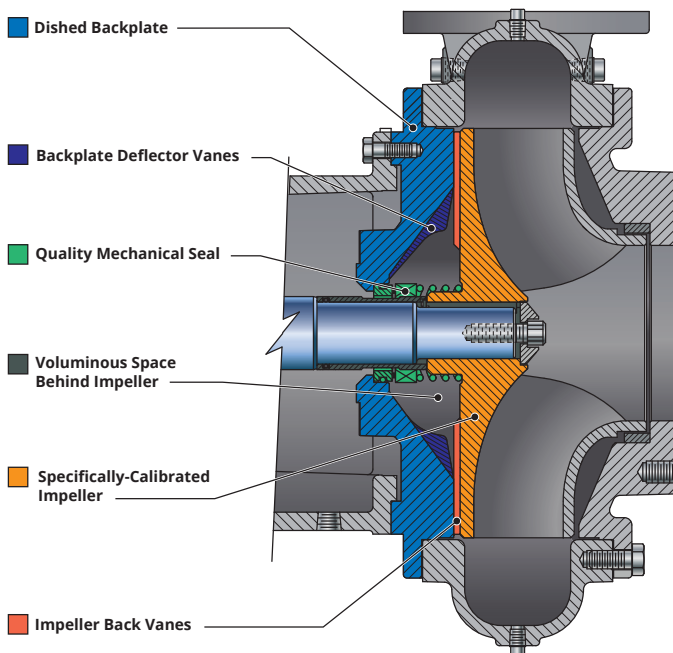

CYCLOSEAL® SYSTEM FOR GRIT REMOVAL

Cycloseal® is patented system with a self-contained single mechanical seal. The Cycloseal pattern cast into the pump backplate in conjunction with contoured impeller back vanes and a dished backplate, creates a pressure gradient that move solids and entrained vapor away from the seal faces. The Cycloseal system is available on most Cornell Pumps.

- Removes grit from pump seal compartment
- Extends pump seal life three times standard mechanical
- No drips/mess at application site
- Reduced maintenance costs
- Increased uptime and reliability
- Removes vapor

CORNELL FEATURES & BENEFITS

CD4MCU STAINLESS STEEL OPTIONS

CD4MCu is a duplex stainless steel, with greater corrosive resistance than 304 stainless steel. CD4MCu allows the pumps to be used in more abrasive applications, and it won't pit like 304 stainless steel, has a better stress/corrosive cracking resistance than 304 stainless, and higher strength than 304 stainless steel. And compared with cast iron material, it is much more resistant to corrosion and much stronger.

Cornell distributors have access to 11 of Cornell's most popular models in CD4MCu, allowing us to slash production time and price. Cornell can supply a CD4MCu pump in as little as one to two weeks.

- Clean Steel
- Usable in pH levels of 2 to 13.5
- Brinell hardness up to 275
- Corrosion and pitting resistance
- Higher strength than 304 stainless steel
- Improved ductility and weldability
- Better resistance to embrittlement

HYDRAULIC BALANCE LINE

Instead of boring large holes in the impeller to lower pressure in the stuffing box, Cornell employs a more effective solution; the external hydraulic balance line.

- Reduces turbulence and improves hydraulic efficiency

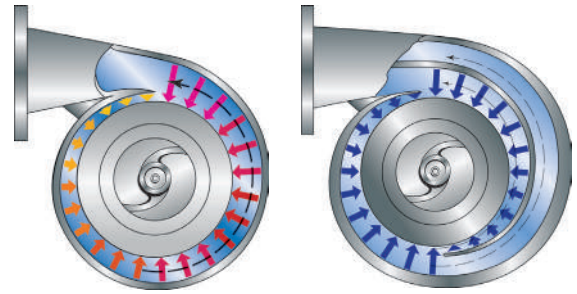

Single Volute

Double Volute

DOUBLE VOLUTE DESIGN

Cornell's double volute system minimizes radial thrust loads common with high capacity, high-head centrifugal pumps, by balancing the radial forces around the impeller.

- Minimizes radial thrust load
 - Eliminates shaft flexing and fatigue
 - Greatly extends life of packing/seal, wear rings and bearings
 - Effectively meets high pressure and high volume requirements
 - Increases bearing life
-
- Increases life of packing (or mechanical seal) and bearings
 - Provides positive control of axial forces
 - Reduces pump wear because abrasives aren't trapped behind impeller/near shaft

MOUNTING CONFIGURATIONS

Cornell's modular frame design allows for easy adaptability. Choose a pump and then pick the mounting configuration best suited to your application. Right-hand and left-hand rotation along with tangential or centerline discharges are available for most pumps.

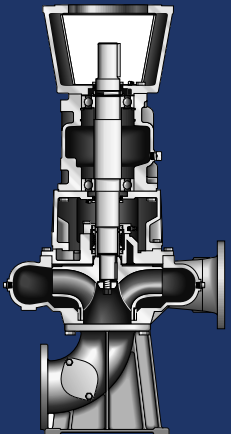

VC
VERTICAL COUPLED

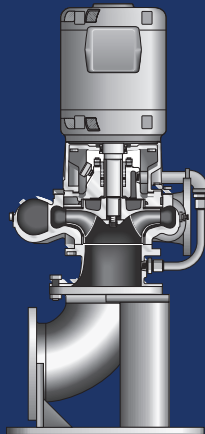

VM VERTICAL
CLOSE COUPLED

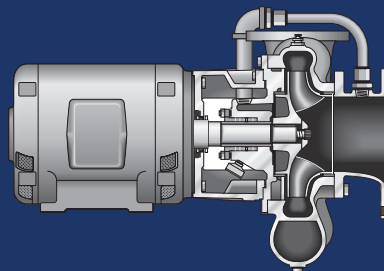

CC
HORIZONTAL CLOSE COUPLED

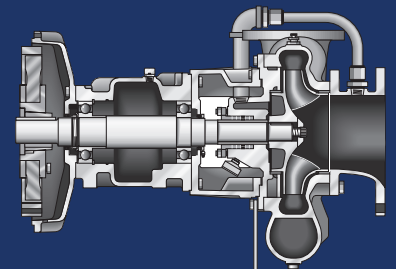

EM ENGINE MOUNTED

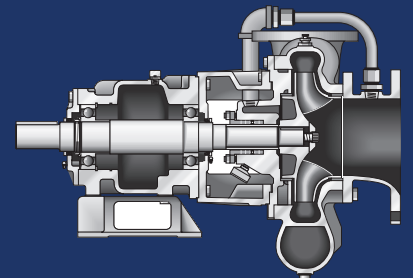

F
HORIZONTAL FRAME MOUNTED



MARKET AND PRODUCT LINE

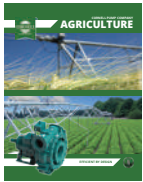

AGRICULTURAL



FOOD PROCESS



INDUSTRIAL



MINE DEWATERING



MUNICIPAL



REFRIGERATION



OIL & GAS



CYCLOSEAL®



CHOPPER



CUTTER



EDGE™



HYDRAULIC SUBS



HYDRO TURBINE



IMMERSIBLE



MANURE



MP SERIES



MX SERIES



MX MINING

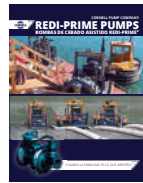

REDI-PRIME®

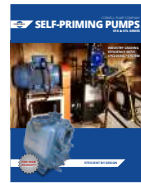

SELF PRIMING



SLURRY



SUBMERSIBLE



WATER TRANSFER



V SERIES

Cycloseal® and Redi-Prime® are Registered Trademarks of Cornell Pump Company.

Cornell pumps and products are the subject of one or more of the following U.S. and foreign patents: 3,207,485; 3,282,226; 3,295,456; 3,301,191; 3,630,637; 3,663,117; 3,743,437; 4,335,886; 4,523,900; 5,489,187; 5,591,001; 6,074,554; 6,036,434; 6,079,958; 6,309,169; 2,320,742; 96/8140; 319,837; 918,534; 1,224,969; 2,232,735; 701,979 and are the subject of pending U.S. and foreign patent applications.

CORNELLPUMP.COM
©2015 CORNELL PUMP COMPANY



Cornell Pump Company
Clackamas, Oregon, USA
P: +1 (503) 653-0330
F: +1 (503) 653-0338

AUTHORIZED CORNELL PUMP DISTRIBUTOR